

D-Line
Trade

Innovative Cable Management

Where time, safety and appearance matter

Listed in **Trimble**
LUCKINS



Trunking overview	
About D-Line	pg 3
A quick guide	pg 4
Case study	pg 5
Micro trunkings	pg 6
20x10mm ½-round trunking	pg 7
30x15mm ½-round trunking	pg 8
Adaptors & Surface boxes	pg 9
50x25mm ½-round trunking	pg 10
Trunking & accessory part codes	pg 11
Safe-D Reg Requirements	pg 12
U-Clip 30 & 30 Red	pg 13
U-Clip 40 & 50	pg 14
F-Clip folding options	pg 15
F-Clip 30 & 40	pg 16
Stainless Steel Cable Ties	pg 16
F-Clip 50 (& ITW Pulsa fixings)	pg 17
Spring Clip	pg 18
Conduit Saddles	pg 19
Adjustable Cable Clips	pg 20
EV Cable Fixing Packs	pg 21
Stag Clips & Drill Bits	pg 22
T&E Grip Clips	pg 23
Retro Clips	pg 24
D-Fixing screws & Drill Bits	pg 25
Cable Safety Overview	pg 26
Floor Cable Protectors	pg 27
Rigid Cable Protectors	pg 28
Cable Zipper	pg 29
Socket Enclosures & Split Cable Tube	pg 30
Spiral Wrap & Cable Band	pg 31
Other Guides	pg 32





D-Line is a UK company, based in Newcastle upon Tyne, with 26x patents, 75x registered designs & a global reputation for innovative cable management products.



For specifiers & installers we offer non-metallic trunking systems, fire-rated cable supports, floor cable protectors, & alternative cable organisers. This Guide highlights D-Line's core products where the labour-saving or functionality make best choices **'for use where time, safety & appearance matter'**.

Full details of other innovative D-Line products are available in our specialist brochures, and website, or please contact D-Line sales team who will be happy to assist.

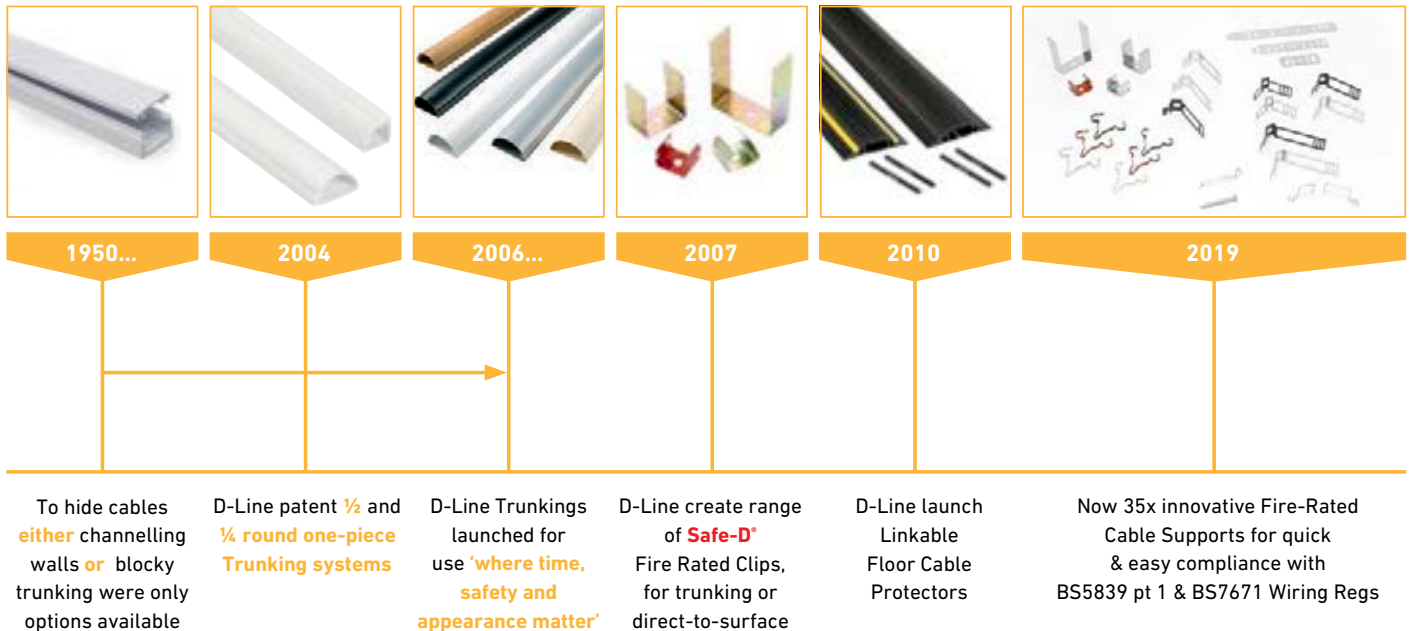
Most D-Line products are manufactured in the UK, fully tested and certified to highest quality requirements. All are made to most exacting standards.

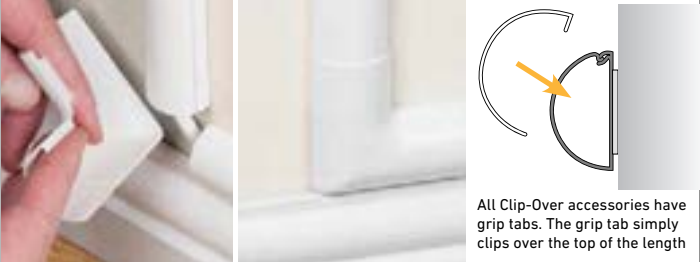

D-Line Trunking - A Quick Guide

	<p>Designer shapes and colours</p> <p>Subtle appearance with no sharp edges; to blend with decor Alternative cable capacities satisfy popular demands Colour options to provide a striking feature!</p> <p>Available as (width x height) 16x8mm, 20x10mm, 30x15mm & 50x25mm</p> <p>Impact-resistant & easy to clean</p>
	<p>Film covered, PVC lengths</p> <p>Keeps lengths pristine before installation PVC lengths, UV stabilized Strong, but easy to cut Safety tested & certified Easy to cut if required</p>
	<p>Self-adhesive</p> <p>Simply peel & stick Can be drilled also</p>
	<p>Patented single-piece design</p> <p>For quick & easy handling Tensioned hinge lid retains cables during installation Hinge is not overly stiff or slack, can be opened/closed millions of times - easy to later add or remove cables Lids will never peel or detach - maintenance friendly Fully safety tested and certified to BS EN 50085-1:2005</p>
 <p>All Clip-Over accessories have grip tabs. The grip tab simply clips over the top of the length</p>	<p>Accessories</p> <p>Push-on design with rear grip tabs hold accessories securely Smooth-fit connectors & end caps Range of adaptors to join with socket blocks and other interfaces</p>
	<p>Easy-clean profile</p> <p>No flat dust-ledges Only one groove, for infection control Easily wipes clean</p> 
	<p>Paintable</p> <p>Can blend with any decor</p>

- D-Line offer inexpensive and practical alternatives to *either* channelling walls *or* traditional mini-trunking
- In occupied in-use buildings, D-Line saves significant time, hassle & cost!
- D-Line installations complement the interior designs of modern spaces, in ways that are appreciated by all stakeholders



When 20,000 hotel rooms needed to hide cables for new heating controllers, D-Line Mini Trunking proved the perfect choice... using D-Line saved a small fortune compared to the cost of channelling the walls, then needing to co-ordinate works to re-plaster and re-decorate.

Aside the noise and disruption, trying to recess the cabling would have put rooms out-of-service. However traditional trunking did not look suitable for a hotel chain with a reputation for comfort and style.

Cables from wall mounted heaters to wall mounted controllers were concealed in D-Line Mini Trunking which blended with the skirting, and, when necessary, up-and-around bedheads.

A cut-length rose up to the heater via a Clip-Over Equal Tee, while Clip-Over Internal Bends made internal corner connections quick and easy. The Flat Bend required was a Smooth-Fit version, as the secure internal tabs were favoured to eliminate future maintenance concerns, given that this part was most likely to be bumped by guests' baggage.

The ½ round shape of the length rising up to the wall-mounted controller was preferred also for its impact resistance, the lack of sharp edge a distinct benefit (compared to traditional sharp edge trunking).

The D-Line Cutting Tool was used throughout, saving time and leaving no PVC dust residue. The self-adhesive tape was used to attach the lengths to the walls, with a screw-fixing and plug then inserted 750mm from each end.

The result was 20,000 installations using 200km - all easy to fit, quick to install and blending with decor.

Further details on request.



Unique Clip-Over Accessories

Saves Channelling Walls

Quick and Easy to Fit

Micro Trunkings

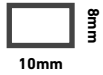

Square/Rectangular Trunking - 10mm x 8mm



D-Line 10x8mm is an ultra-slim profile for the smallest of cables, & suitable for tight spaces.

Ideal for alarm cables, bellwire, telephone & speaker cables.

- Rectangular profile, 10x8mm (WxH)
- Clip-on lid
- Corners can be mitre-cut
- Self-adhesive
- Paintable



Code	Description	Colour
DLFSA108W/2	(L) 2m x (W) 10mm x (H) 8mm	White



Micro Trunking - 16mm x 8mm



To hide speaker cable, bell wires, telephone and alarm cable, Micro Trunking offers a discreet solution.

Available in a choice of colours and with a range of Smooth-Fit accessories; that give a flush appearance.

- Micro ½ round profile, only 16x8mm (WxH)
- Patented hinge & click-lock lid
- Smooth-Fit accessories available for perfect finish
- Self-adhesive, or can be drilled & screw-fixed
- If required, cable retaining Safe-D Spring Clips can be fitted internally



Code	Description	Colour
R2D1608W	(L) 2m x (W) 16mm x (H) 8mm	White
R3D1608W	(L) 3m x (W) 16mm x (H) 8mm	White



Magnolia, Aluminium Effect, Black & Oak Effect available on request.



With fire-rated Spring Clip



D-Line 20x10mm Micro+ profile gives a neat solution for single cables, while offering additional internal capacity that can be useful around corners.

Complementary Clip-Over bends and tees can provide a perfect finish and are quick & easy to install.

Ideal for flexible cables (up to 8mm outer diameter), also fibre-optic, satellite/aerial and broadband cable installations.

- Discreet and stylish appearance; only 20x10mm (WxH)
- Patented hinge & click-lock lid
- Clip-Over accessories available for perfect finish
- Self-adhesive, or can be drilled & screw-fixed
- If required, cable retaining Safe-D Spring Clips can be fitted internally



Full range of accessories available

Code	Description	Colour
R2D2010W	(L) 2m x (W) 20mm x (H) 10mm	White
R3D2010W	(L) 3m x (W) 20mm x (H) 10mm	White



Magnolia & Black available on request.

Mini Trunking - 30mm x 15mm

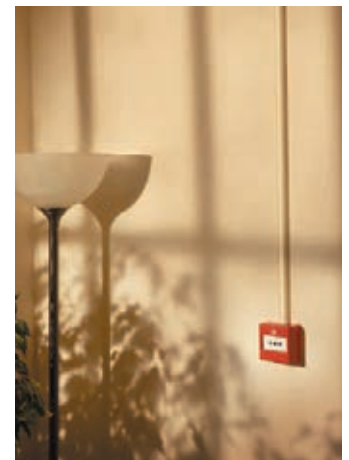
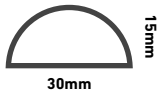

D-Line 30x15mm Mini Trunking offers a subtle appearance to make surface cable installations look attractive!

The ½ round shape can blend to resemble the natural top-section of skirting boards, while offering a modern solution for vertical cable drops and runs across ceilings.

Available in a variety of colours that can blend with surrounds or create a striking visual feature, this versatile profile is popular for 2x 2.5mm T&E, 2x 1.5mm 2c FP cables, 2x broadband cable and 4x Cat-5 combinations.

- Unique stylish 'D-Line' appearance
- Self-adhesive, or can be drilled & screw-fixed
- Clip-Over & Smooth-Fit accessories for perfect finish
- Adaptors enable popular connections **see page 9**
- Can contain Safe-D U-Clip 30 to secure cables

Code	Description	Colour
R2D3015W	(L) 2m x (W) 30mm x (H) 15mm	White
R3D3015W	(L) 3m x (W) 30mm x (H) 15mm	White
R3D3015B	(L) 3m x (W) 30mm x (H) 15mm	Black



Magnolia, Aluminium Effect & Oak Effect available on request.



Full range of accessories available



With U-Clip 30

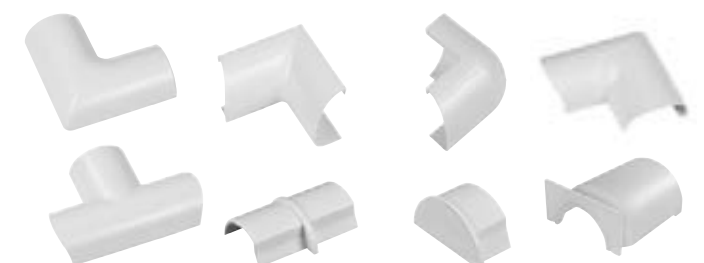

Adaptors for easy connections - to D-Line 30x15mm ½ Round Trunking

Pattress Adaptor - Connect 30x15mm Mini Trunking to circular pattresses



Flat Adaptor - Connect 30x15mm Mini Trunking to flat surfaces



Box Adaptor - For use between 30x15mm Mini Trunking and D-Line Surface Boxes



Surface Boxes - Single & Twin 28mm & 35mm Depths available



Maxi Trunking - 50mm x 25mm

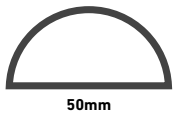

D-Line 50x25mm Maxi is a versatile trunking, providing capacity for several cables.

The size, capacity and range of colours makes this profile a market-leading solution that is ideal for many AV, electrical and datacoms projects.

- Unique stylish 'D-Line' appearance
- Saves channelling walls
- Self-adhesive, or can be drilled & screw-fixed (as recommended for best practice)
- Clip-Over & Smooth-Fit accessories for perfect finish

Code	Description	Colour
R3D5025W	(L) 3m x (W) 50mm x (H) 25mm	White



Magnolia, Aluminium Effect, Black & Oak Effect available on request.

½ round Clip-Over Accessories - for 20x10mm, 30x15mm and 50x25mm



Internal Bend

Join lengths around 90 degree inside corners.



External Bend

Join lengths around 90 degree outside corners.



Flat Bend

Change direction by 90 degrees on flat surfaces.



Equal Tee

Use to join 3 lengths of same profile.



Door Top Bend

Change direction by 90 degrees around frame tops.



Reducing Tee

Connect 2x 50x25mm lengths to 1x 30x15mm length.



Skirting Tee

Connect 1x 50x25mm length to 2 x 30x15mm lengths.



Box Adaptor Tee

For use with D-Line Surface Socket Boxes. **50x25mm only**



Flat Adaptor

Connect Mini Trunking to flat surfaces **30x15mm only**

½ Round 16x8mm Micro Trunking

		White
Lengths	3m Length	R3D1608W
	2m Length	R2D1608W
Accessories	Smooth-Fit Internal Bend	IB1608W
	Smooth-Fit External Bend	EB1608W
	Smooth-Fit Flat Bend	FB1608W
	Smooth-Fit Equal Tee	NET1608W
	Smooth-Fit Coupler	NCP1608W
	Smooth-Fit End Cap	EC1608W

½ Round 20x10mm Micro+ Trunking

		White
Lengths	3m Length	R3D2010W
	2m Length	R2D2010W
Clip-Over Accessories	Clip-Over Internal Bend	FLIB2010W
	Clip-Over External Bend	FLEB2010W
	Clip-Over Flat Bend	FLFB2010W
	Clip-Over Equal Tee	FLET2010W
Smooth-Fit Accessories	Smooth-Fit Coupler	CP2010W
	Smooth-Fit End Cap	EC2010W

½ Round 30x15mm Mini Trunking

		White	Black
Lengths	3m Length	R3D3015W	R3D3015B
	2m Length	R2D3015W	R2D3015B
	3m Self Adhesive Internal Divider	3AD3015L	-
Clip-Over Accessories	Clip-Over Internal Bend	FLIB3015W	FLIB3015B
	Clip-Over External Bend	FLEB3015W	FLEB3015B
	Clip-Over Flat Bend	FLFB3015W	FLFB3015B
	Clip-Over Door Top Bend	FLDB3015W	FLDB3015B
	Clip-Over Equal Tee	FLET3015W	FLET3015B
	Clip-Over Flat Adaptor	FA3015W	-
Smooth-Fit Accessories	Smooth-Fit Coupler	CP3015W	CP3015B
	Smooth-Fit End Cap	EC3015W	EC3015B
	Smooth-Fit Pattress Adaptor	PA3015W	-
	Smooth-Fit Circular Adaptor	CA3015W	-
	Smooth-Fit Box Adaptor	BA3015W	BA3015B
	Smooth-Fit Box Adaptor Tee	AT3015W	AT3015B

½ Round 50x25mm Trunking

		White
Lengths	3m Length	R3D5025W
	2m Length	R2D5025W
	3m Self Adhesive Internal Divider	3AD5025L
Clip-Over Accessories	Clip-Over Internal Bend	FLIB5025W
	Clip-Over External Bend	FLEB5025W
	Clip-Over Flat Bend	FLFB5025W
	Clip-Over Equal Tee	FLET5025W
	Clip-Over Box Adaptor Tee	FLAT5025W
	Clip-Over Reducing Tee 2x 50x25mm > 1x 30x15mm	FLRT5030W
	Clip-Over Skirting Tee 1x 50x25mm > 2 x 30x15mm	FLST5030W
Smooth-Fit Accessories	Smooth-Fit Coupler	CP5025W
	Smooth-Fit End Cap	EC5025W
	Smooth-Fit Box Adaptor Tee	AT5025W



28mm Deep Standard Corner Boxes

Code	Description	Colour
SSB28W	(L) 87mm x (W) 87mm x (H) 28mm	White

35mm Deep Standard Corner Boxes

Code	Description	Colour
SSB35W	(L) 87mm x (W) 87mm x (H) 35mm	White

Rounded Corner Boxes

Code	Description	Colour
SSB28RW	(L) 87mm x (W) 87mm x (H) 28mm	White
SSB35RW	(L) 87mm x (W) 87mm x (H) 35mm	White

28mm Deep Standard Corner Boxes

Code	Description	Colour
TSB28W	(L) 147mm x (W) 87mm x (H) 28mm	White

35mm Deep Standard Corner Boxes

Code	Description	Colour
TSB35W	(L) 147mm x (W) 87mm x (H) 35mm	White

Rounded Corner Boxes

Code	Description	Colour
TSB28RW	(L) 147mm x (W) 87mm x (H) 28mm	White
TSB35RW	(L) 147mm x (W) 87mm x (H) 35mm	White



½ round ranges also available on request

Saving Lives



- The IET Wiring Regulations 18th Edition became effective 1st January 2019. It describes (p5) as a 'significant change' the need to fix all cables throughout the installation, not only escape routes.
- 'Chapter 52 Selection and erection of wiring systems' s521.10.202 states

"Wiring systems shall be supported such that they will not be liable to premature collapse in event of a fire."

Compared to previous wording (i.e. 2015 17th Edition Amendment), this evolution makes no reference to 'escape routes', so applies to all areas.

- Note 1 - "Wiring systems hanging across access or egress routes may hinder evacuation and fire-fighting activities."
- Note 2 - "Cables installed in or on steel cable containment systems are deemed to meet the requirements of this regulation."
- Note 3 - **"This regulation precludes**, for example, the use of non-metallic cable clips or cable ties as the sole means of support where cables are clipped direct to exposed surfaces or suspended under cable tray, and **the use on non-metallic cable trunking as the sole means of support of the cables therein.**"
- Note 4 - steel or copper clips, saddles or ties are examples that will meet the requirements of this regulation."

In context of regulations, it is accepted that 'shall' means 'must'.

Now all cables wherever installed must be supported so they will not collapse prematurely in fire & potentially hinder evacuation and firefighting activities.

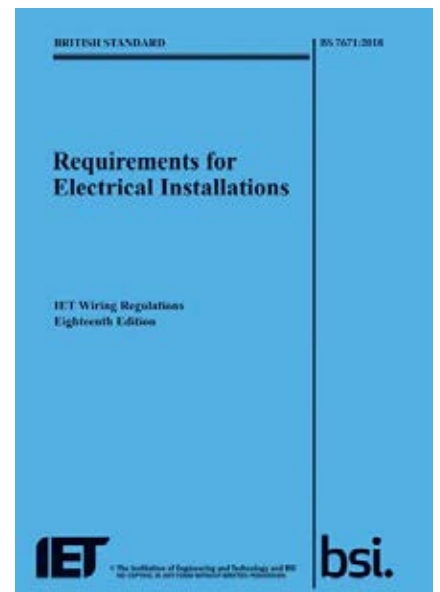

Safe-D U-Clip 30 & 30 Red - Fully tested & certified

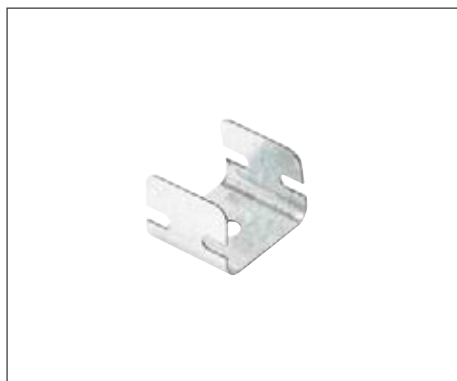
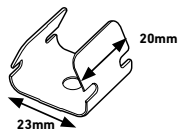

1st fix clips, then 2nd fix cables!

- Certified for 2 hours at 970°C
- Compliant with BS7671 and BS5839-1 requirements
- Thumb friendly, easy fold side-tabs
- Ideal for ceiling voids, or popular PVC trunking
- Rounded edges for easy handling
- Red U-Clips are popular for fixing direct to surface
- Supplied in bags of 100 pcs

Code	Description
SAFE-D30/100	(L) 20mm x (W) 23mm x (H) 8mm (folded) 5.7mm diameter pre-drilled hole in base
SAFE-D30/RED/100	(L) 20mm x (W) 23mm x (H) 8mm (folded) 5.7mm diameter pre-drilled hole in base

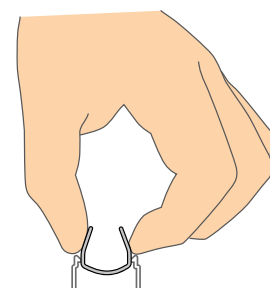
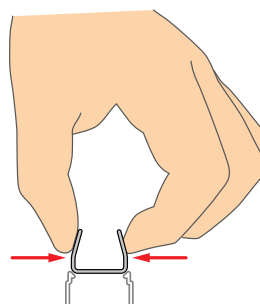
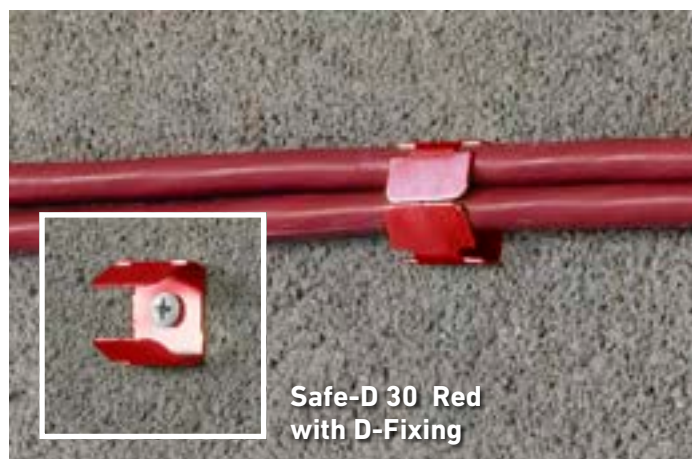

When inserting U-Clip 30 in 25x16mm trunkings, gently squeezing the upright tabs causes the base to compress for tight fitment in Size 2 trunkings.

Safe-D U-Clip 40 & 50 - For 38mm - 50mm+ Trunkings

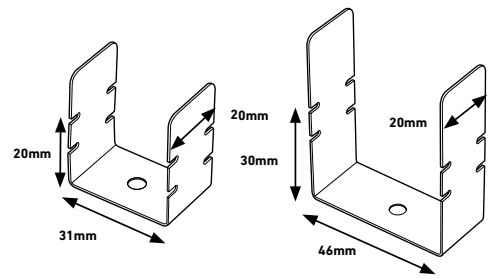

Safe-D U-Clip 40 is ideal for fitment in 38mm or 40mm non-metallic trunking bases, or to provide a first-fix solution for securing cables direct to surfaces.

Safe-D U-Clip 50 Clips are popular for fitment in 50mm non-metallic trunking bases, or to provide a first-fix solution for securing cables direct to surfaces.

Installers should use a fire-rated fixing, such as D-Line D-Fixings (see page 25), and then simply fold-over tabs to secure cables.

1st fix clips, then 2nd fix cables!

- Certified for 2 hours at 970°C
- Compliant with BS7671 and BS5839-1 requirements
- Thumb friendly, easy fold side-tabs
- Ideal for ceiling voids, or popular PVC trunking
- Rounded edges for easy handling
- Supplied in bags of 50 pcs



Code	Description
SAFE-D40/50	(L) 20mm x (W) 31mm x (H) 20mm (folded) 5.7mm diameter pre-drilled hole in base
SAFE-D50/50	(L) 20mm x (W) 46mm x (H) 30mm (folded) 5.7mm diameter pre-drilled hole in base



Safe-D F-Clips - Flat-form, flexible and foldable, fire-rated cable supports

F-Clips offer unique versatility for multiple uses...

Safe-D F-Clip 30

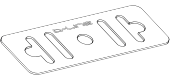

Safe-D F-Clip 40

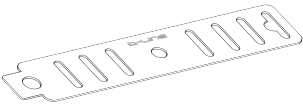

Safe-D F-Clip 50

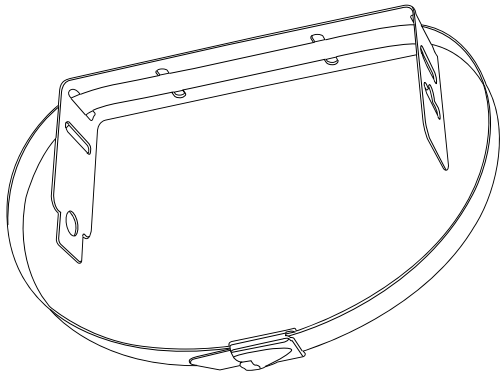
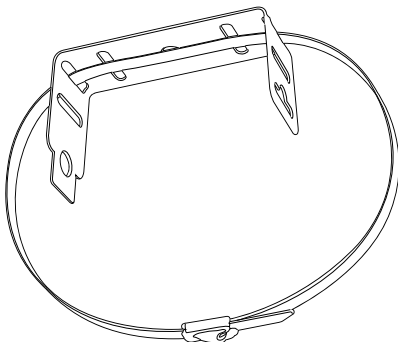
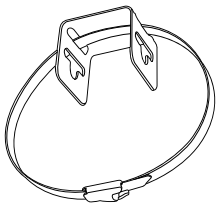
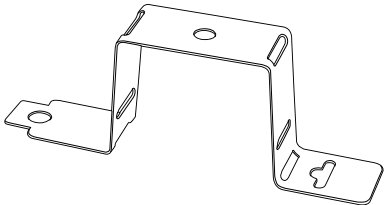
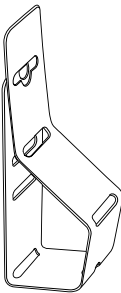
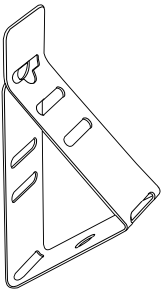
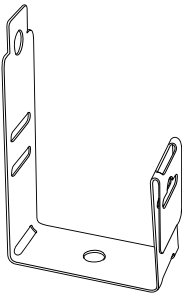
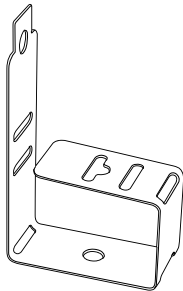
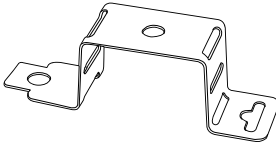
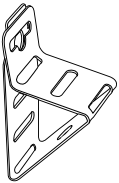
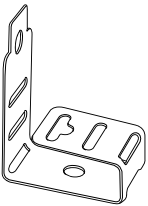
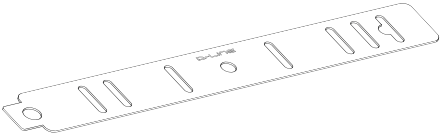

Safe-D F-Clip 30 & 40 - Flex, Fit, Fold

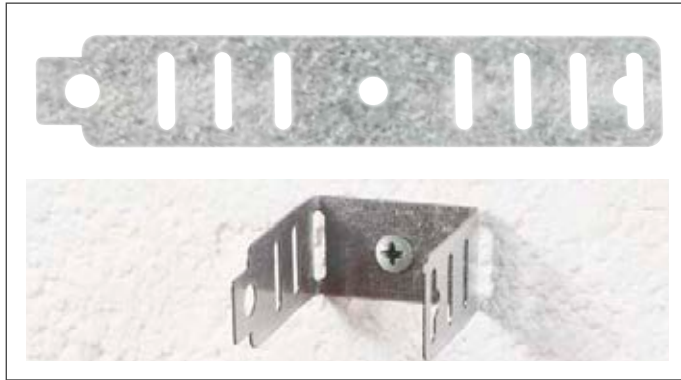
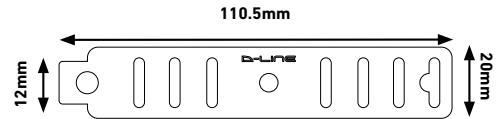
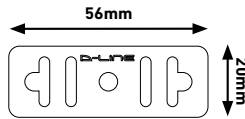

Safe-D F-Clip 30 is a fire-rated flexible cable clip that is supplied in flat form, and can be quickly folded to secure cable installations.

- Supplied flat...
 - Space efficient and pocket friendly
 - Easier handling - to save installation time
 - Easy folding to consider space and cable volume
 - Perfect for shot fired fixings
- Compliant with BS7671 and BS5839-1 requirements
- >1200°C melting point
- Slots enable use as cable tie base
- 3x fixing holes for versatility, ideal for use with D-Line D-Fixings
- Thumb friendly, rounded corners, 20mm wide, and pliable for easy installation
- Fit direct to surface, or in PVC trunkings
- Easy to later add or remove cable(s)
- Uniquely versatile - for shaping as required

Code	Description
SAFEDFLCIP30/100	(L) 56mm x (W) 20mm x (H) 8mm (folded) 5.7mm diameter pre-drilled hole in base
SAFEDFLCIP40/50	(L) 110.5mm x (W) 20mm x (H) 20mm (folded) 5.7mm diameter pre-drilled hole in base



Safe-D Stainless Steel Cable Ties - High Tensile Strength

Ideal for holding bundles of cables, D-Line Cable Ties can be slotted via notches on F-Clips, with the F-Clip acting as the Cable Tie base.

- Enabling fastening of cable bundles
- Secure locking mechanism
- Compatible with Safe-D F-Clips
- Supplied in bags of 100 pcs



Code	Description
SD-TIE360/100	(L) 360mm x (W) 4.6mm
SD-TIE200/100	(L) 200mm x (W) 4.6mm



Safe-D F-Clip 50 - Flex, Fit, Fold & Lock

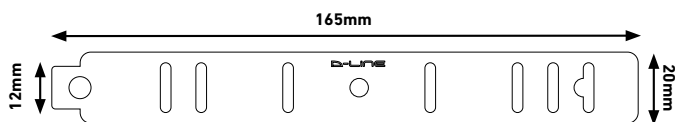

Safe-D F-Clip 50 is a fire-rated flexible cable clip that is supplied in flat form, and can be folded to make a variety of shapes to most effectively secure cable installations.

- Supplied flat...
 - Space efficient and pocket friendly
 - Easier handling - to save installation time
 - Easy folding to consider space and cable volume
 - Perfect for shot fired fixings
- Compliant with BS7671 and BS5839-1 requirements
- >1200°C melting point
- Locking feature to hold cables most securely... simply push the tab through the preferred notch
- Locking tabs can be return-folded for a more secure installation
- 3x fixing holes for versatility, ideal for use with D-Line D-Fixings
- Fit direct to surface, or in PVC trunkings
- Easy to later add or remove cable(s)
 - Can be opened/closed up to 5x
- Supplied in bags of 50 pcs

Code

SAFEDFCLIP50/50

Description

(L) 165mm x **(W)** 20mm x **(H)** 35mm (folded)
5.7mm diameter pre-drilled hole in base



Safe-D Spring Clip

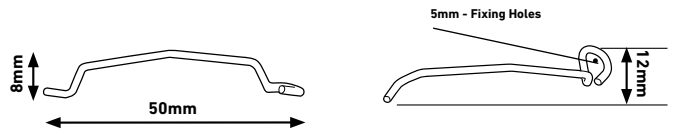

- The spring-tensioned arm drops over to secure cables
- Adjustable according to volume of cables

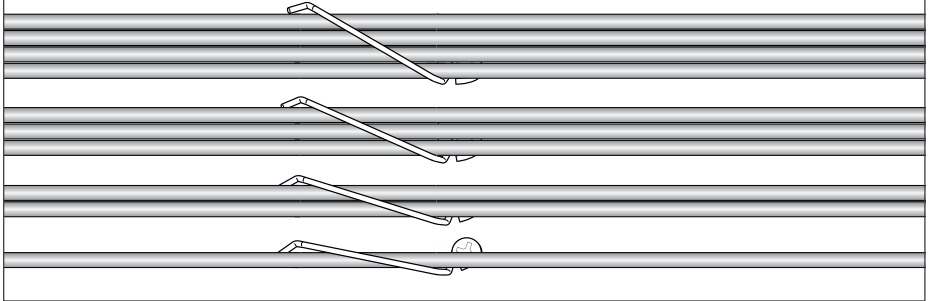

Ideal for direct-to-surface, or can fit micro trunking lengths 10mm - 20mm wide

Drill a 4mm pilot hole off-centre in the trunking and secure with the D-Fixing

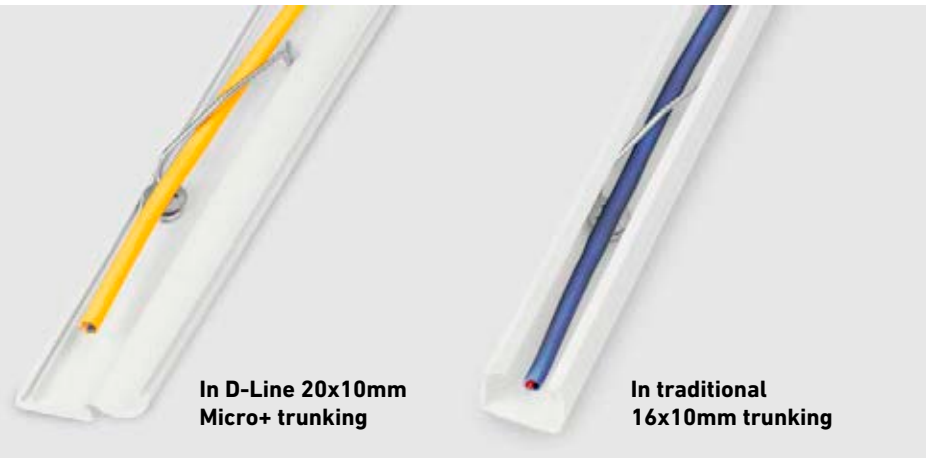

Safe-D Spring Clips effectively secure single cables (<7mm o/d), either direct to surface, or in PVC micro trunkings.

- Compliant with BS7671 and BS5839-1 requirements
- Sprung tensioned steel
- >1200°C melting point
- Fixing hole is ideal for use with D-Line D-Fixings
- Heightened kink along length minimises risk of cable bruising
- Can be positioned at alternative angles according to application or volume of cables to be secured
- Easy to add or remove cables
- Supplied in bags of 50 pcs



Code	Description
SAFEDSPRING/50	(L) 50mm x (W) 12mm x (H) 8mm 5mm diameter fixing hole

Safe-D 20mm + 25mm Conduit Saddles

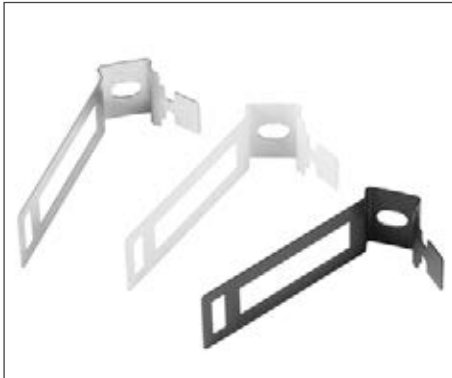
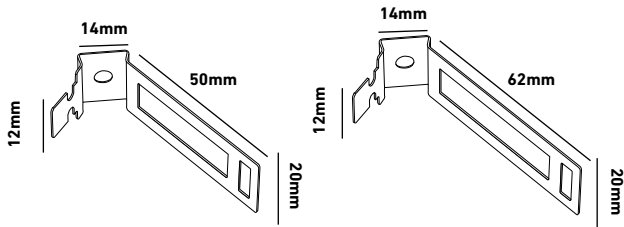

Provides a 3mm stand off from the surface



Simply wrap around the conduit, perfect for tight spaces



Secure conduit with locking tab

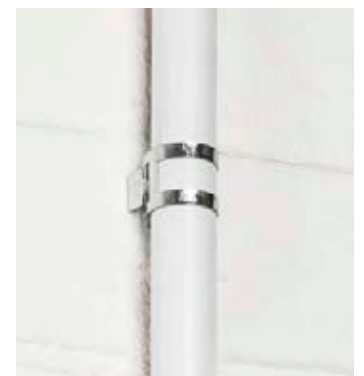

Centralised base fixing, gives a neat appearance to installation

Safe-D Conduit Saddles combine fire performance, quickest fix, and a modern look, to secure cables in 20mm & 25mm outer diameter PVC and galvanised conduit installations... & 20mm or 25mm o/d cables and pipes.

1 piece for only 1 fixing!

- Modern, stylish appearance
- Ideal for tight spaces
- Compliant with BS7671 and BS5839-1 requirements
- Non-corrosive finish
- Unique single piece fixing, only 1x screw required - labour-saving design
- Fixing hole is ideal for use with D-Line D-Fixings
- Available in white, black or galvanised finish
- Adjustable slot in base for fixings
- Supplied in boxed quantity of 100 pcs (bags of 20 pcs on request)

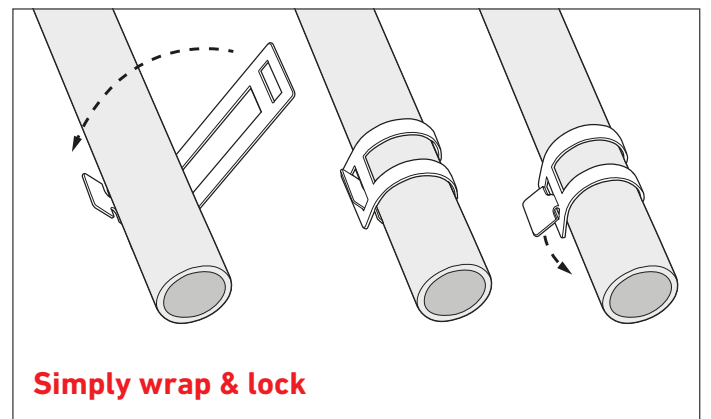

Simply wrap & lock

Code	Description	Colour
SAFE-DCOND20/100	(L) 86.19mm x (W) 20mm x (H) 23mm (folded)	Galv
SAFE-DCOND20W/100	(L) 86.19mm x (W) 20mm x (H) 23mm (folded)	White
SAFE-DCOND20B/100	(L) 86.19mm x (W) 20mm x (H) 23mm (folded)	Black
SAFE-DCOND25/100	(L) 100mm x (W) 20mm x (H) 28mm (folded)	Galv
SAFE-DCOND25W/100	(L) 100mm x (W) 20mm x (H) 28mm (folded)	White
SAFE-DCOND25B/100	(L) 100mm x (W) 20mm x (H) 28mm (folded)	Black

Safe-D Adjustable Cable Clips

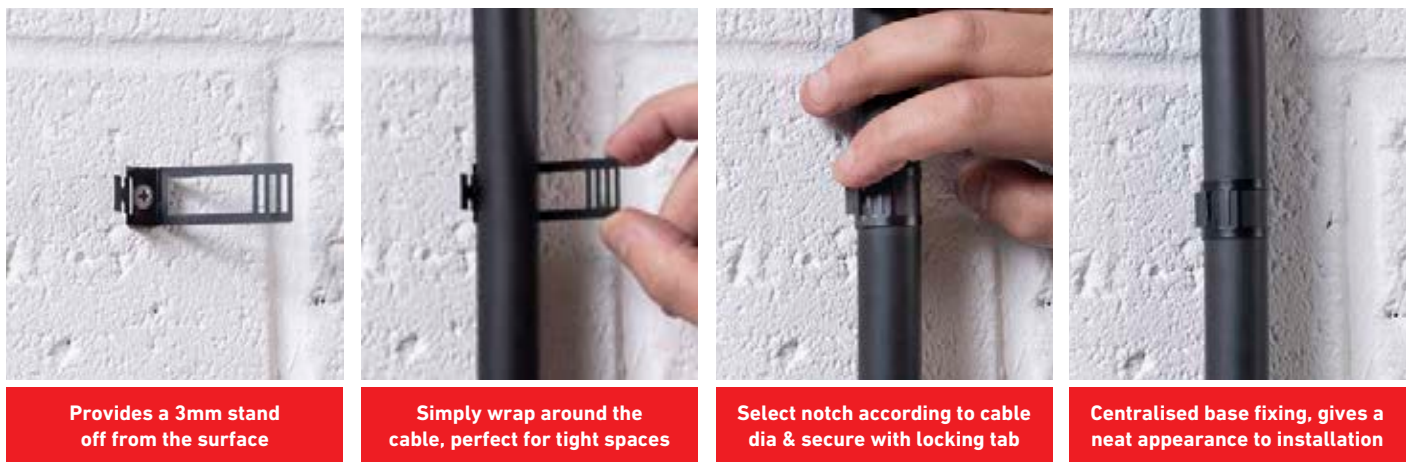
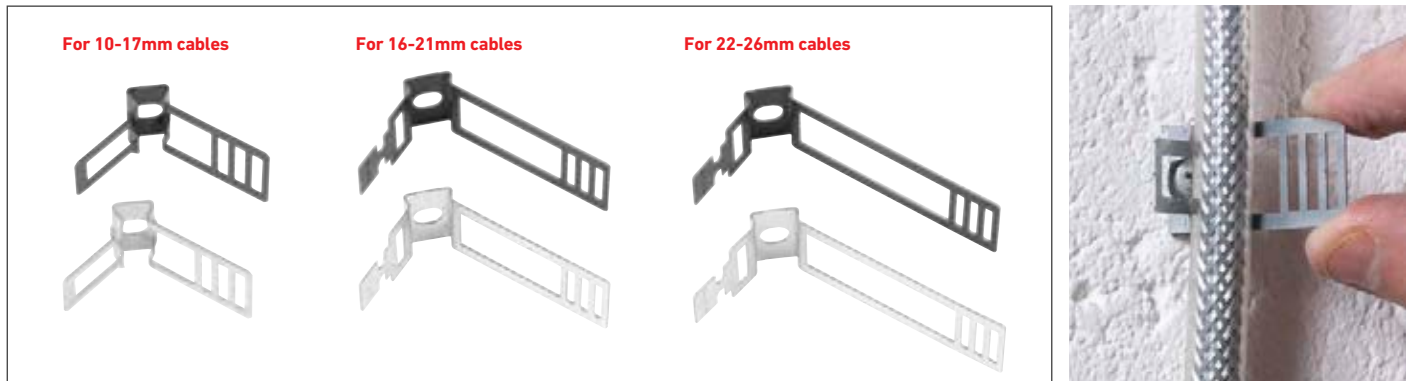

Provides a 3mm stand off from the surface

Simply wrap around the cable, perfect for tight spaces

Select notch according to cable dia & secure with locking tab

Centralised base fixing, gives a neat appearance to installation

Popular for armoured cables and EV cables, Safe-D Cable Clips secure cables having diameters ranging between 10mm and 26mm.

- Select the most appropriate slot, then fold-down the tab to achieve a tight fitment around the cable
- Oval shape of base hole enables the Safe-D Cable Clip to be adjusted left or right-side
- 3mm stand-off above base
- Type 1 for cables (or pipes) between 10-17mm diameters
- Type 2 for cables (or pipes) between 16-21mm diameters
- Type 3 for cables (or pipes) between 22-26mm diameters
- >1200°C melting point

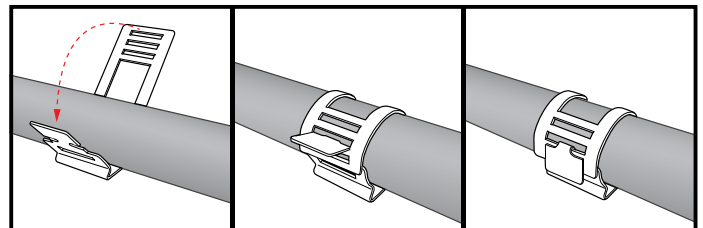

Simply wrap & lock

Code	Description	Colour
SD-CAB10	(L) 75mm x (W) 20mm x (H)	Galv
SD-CAB10B	(L) 75mm x (W) 20mm x (H)	Black
SD-CAB16	(L) 89mm x (W) 20mm x (H)	Galv
SD-CAB16B	(L) 89mm x (W) 20mm x (H)	Black
SD-CAB22	(L) 104mm x (W) 20mm x (H)	Galv
SD-CAB22B	(L) 104mm x (W) 20mm x (H)	Black



EVFIX10B - For 10-17mm diameter cables

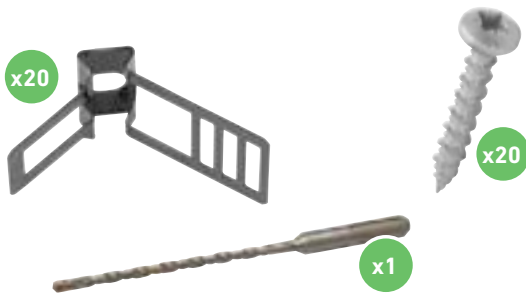

EVFIX16B - For 16-21mm diameter cables

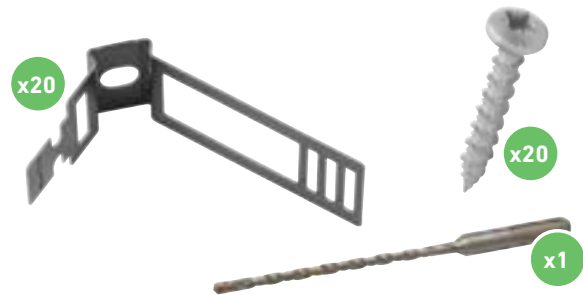

Drill a 5mm pilot hole



Secure screw-fix, no wall plug required



Simply wrap around the cable



Secure cable with locking tab



Tight fitment, neat appearance

These Cable Fixing Packs are ideal for EV charging cables. Each pack contains 20x fire-rated screws for masonry, concrete & brickwork; with no wall-plug required. The 20x Clips are produced from fire-rated steel, which can adjust to different cable diameters by a tight wrap & lock mechanism that gives installations a perfect finish.

- Wrap & lock fire-rated clip
- Tight fitment, stylish design
- Secure screw-fix, no wall plug required
- Handy packs c/w clips, screws & drill-bit

Code	Description
EVFIX10B	20x Fire-Rated Clips for cables 10-17mm dia, Black, 20x Pan-Head Screws, 1x 5mm Drill Bit
EVFIX16B	20x Fire-Rated Clips for cables 16-21mm dia, Black, 20x Pan-Head Screws, 1x 5mm Drill Bit

Safe-D Stag Clips



Stag Clip Single

Stag Clip Twin

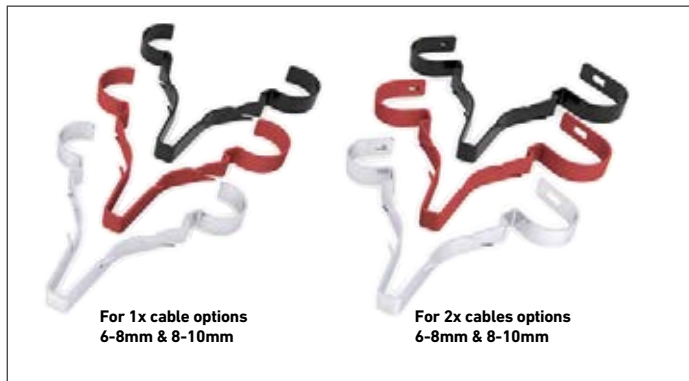

For 1x cable options
6-8mm & 8-10mm

For 2x cables options
6-8mm & 8-10mm



Drill pilot hole & select appropriate size of Stag Clip



Rest Stag Clip in the pilot hole ready to accept cable(s)



Insert cable(s) before squeezing the smooth head



Push home to secure the Stag Clip and cable(s)

Safe-D Stag Clips can be first-fixed with their lower barbs gripping in pilot-holes, ready for second-fix cabling works.

- >1200°C melting point
- Can be 1st fix rested in pilot hole, before 2nd fix inserting cable(s)
- No screw required, simply push smooth head in pilot hole, 5.5mm or 6mm x 30mm deep*
- Head sections overlap for secure cable fitment. 2x cable versions lock together when overlapped
- Ideal for FP & MICC cables, T&E and flexes
- Supplied in boxed quantity of 100 pcs (bags of 50 pcs on request)

Code	Description	Colour
SAFEDSTAG6S/100	Holds 1x 6-8mm Cable	Galv
SAFEDSTAG6SR/100	Holds 1x 6-8mm Cable	Red
SAFEDSTAG6SB/100	Holds 1x 6-8mm Cable	Black
SAFEDSTAG6T/100	Holds 2x 6-8mm Cable	Galv
SAFEDSTAG6TR/100	Holds 2x 6-8mm Cable	Red
SAFEDSTAG6TB/100	Holds 2x 6-8mm Cable	Black
SAFEDSTAG8S/100	Holds 1x 8-10mm Cable	Galv
SAFEDSTAG8SR/100	Holds 1x 8-10mm Cable	Red
SAFEDSTAG8SB/100	Holds 1x 8-10mm Cable	Black
SAFEDSTAG8T/100	Holds 2x 8-10mm Cable	Galv
SAFEDSTAG8TR /100	Holds 2x 8-10mm Cable	Red
SAFEDSTAG8TB /100	Holds 2x 8-10mm Cable	Black

Safe-D Drill Bits

D-Line drill-bits offer easy ways to make pilot holes. Ideal to pre-form holes, in readiness for use with Stag Clips and D-Fixings

- For use with SDS+ rotary or percussion drills
- Strengthened core ensures high drilling stability
- Ground Tungsten Carbide tip for long life

Code	Description
4MMSDS	4mm Dia 110mm Long 50mm Max drill depth
5MMSDS	5mm Dia 160mm long 100mm Max drill depth





Safe-D T&E Grip Clips are user-friendly by a symmetrical design that makes it easy to hold the clip over T&E cable during installation... keeping finger and thumb away from hammer.

Grip Clips include flat-head nails with 2.5mm diameter shafts that enable effective knock-in to mortar and wood; compared to alternative designs with thinner nails, the 2.5mm shaft minimises the risk of a nail bending or buckling in hard substrates.

- Produced from steel, fire-rated to 1200C+
- Flat-head nail sits tight when knocked-in
- 2.5mm diameter nail body, suitable for harder substrates
- User-friendly design for easy positioning - keeping finger & thumb away from hammer
- 4x sizes for popular T&E clips (1.5, 2.5, 4.0, 6.0mm)²
- Raised strip on clip-head prevents cable bruising if mis-hit!
- All nails have 2.5mm body dia, 5.5mm head dia & 25mm length
- Supplied in boxed quantity of 100 pcs



Code	Description
SD-TE1.5/100	Holds 1x 1.5mm T&E cable
SD-TE2.5/100	Holds 1x 2.5mm T&E cable
SD-TE4.0/100	Holds 1x 4.0mm T&E cable
SD-TE6.0/100	Holds 1x 6.0mm T&E cable

Safe-D Retro Clips

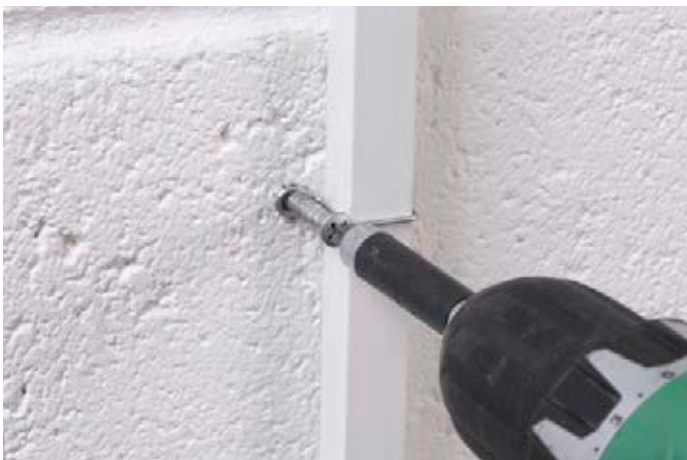
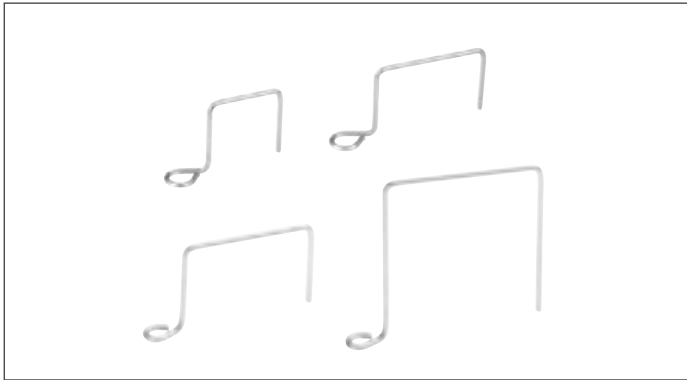
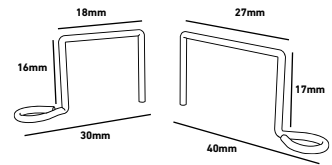

Retro Clips are shaped to fit outside of existing non-metallic trunking installations. They provide an easy-fit solution for trunkings that do not have internal fire-rated supports.

- 4 options available
- 5mm eyelet for screw-fixing - make compliance visible
- Will not drop to cause potentially fatal cable entanglements
- Simply fit 1x screw via 5mm eyelet
- Labour saving - 1 fixing only
- >1200°C melting point
- Supplied in bagged quantity of 50 pcs

Code	Description
SD-RETRO1/50	(L) 30mm x (W) 18mm x (H) 16mm - For Size 1 Trunkings
SD-RETRO2/50	(L) 40mm x (W) 27mm x (H) 17mm - For Size 2 Trunkings
SD-RETRO3/50	(L) 57mm x (W) 40mm x (H) 25mm - For Size 3 Trunkings
SD-RETRO4/50	(L) 65mm x (W) 50mm x (H) 50mm - For Size 4 Trunkings

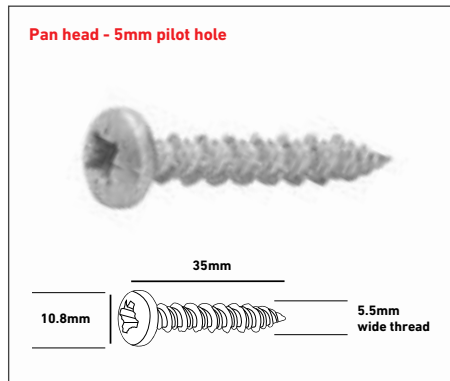
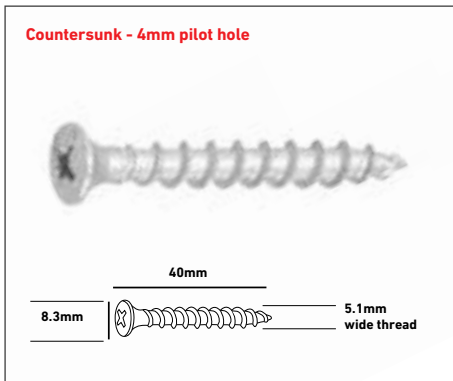

D-Fixing in Safe-D U-Clip 40



D-Fixing in Safe-D F-Clip 50



2x D-Fixings in Safe-D F-Clip 40

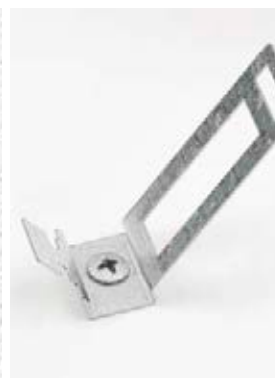

Conduit Saddle 20 with D-Fixing



Spring Clip with D-Fixing

D-Fixings are fire-rated, with close threads for high performance. D-Fixings are ideal for securing D-Line Safe-D ranges, and other electrical installation equipment. D-Fixings can be used in masonry, plasterboard/breeze-block, concrete, brickwork and wood.

D-Fixings have been extensively tested, and are certified to hold Safe-D Clips and cable loads up to 970°C for 2 hours, after withstanding stress vibrations and water sprays also.

In fire tests the D-Fixing screw threads remain securely embedded with no need for anchors or plastic wall plugs (which typically melt at 160°C).

- Compliant with BS7671 and BS5839-1 requirements
- >1200°C melting point
- Non-corrosive finish
- No need for plastic wall plugs
- Excellent tensile strength, shear strength and pull-out load performance
- Supplied in boxed quantity of 100 pcs

Code	Description
DFIX/100	(L) 40mm x (W1) 8.3mm head width x (W2) 5.1mm thread width
DFIX-P/100	(L) 35mm x (W1) 10.8mm head width x (W2) 5.5mm thread width

Safe-D Drill Bits

D-Line drill-bits offer easy ways to make pilot holes. Ideal to pre-form holes, in readiness for use with Stag Clips and D-Fixings

- For use with SDS+ rotary or percussion drills
- Strengthened core ensures high drilling stability
- Ground Tungsten Carbide tip for long life

Code	Description
4MMSDS	4mm Dia 110mm Long 50mm Max drill depth
5MMSDS	5mm Dia 160mm long 100mm Max drill depth



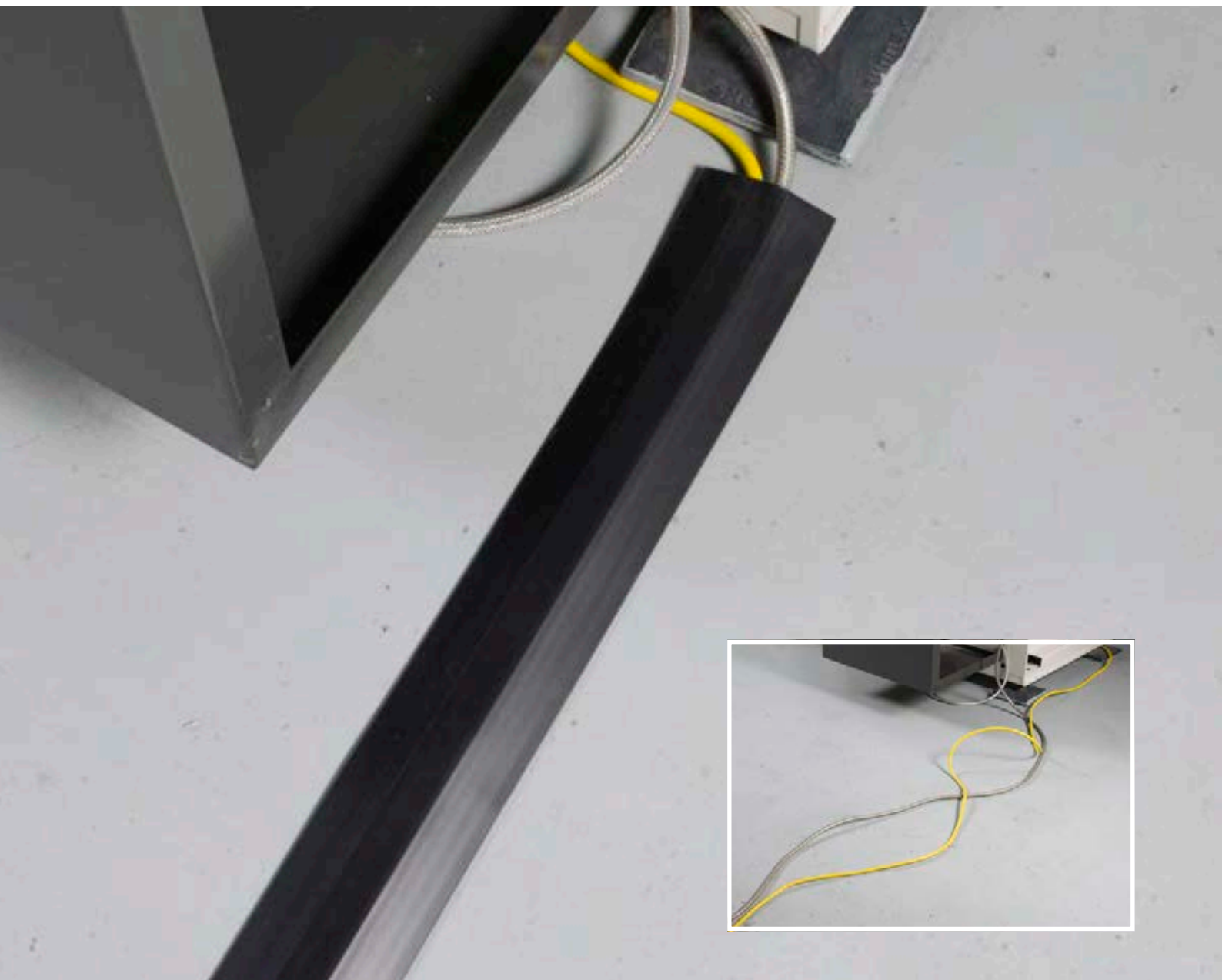

In recent years it is a fact that personal work spaces and living spaces have both reduced, while at the same time the volume of cables around us, and often under our feet, has increased. The impact of both trends make cable management a critical issue, which requires a pro-active and responsible approach.

D-Line cable safety ranges address common dangers from 'cable mis-management', with affordable & unique solutions that can simply retro-fit around existing cables.

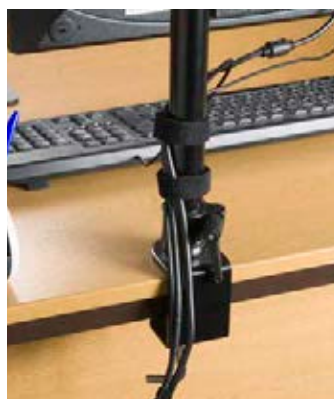



Medium Duty Floor Cable Protectors

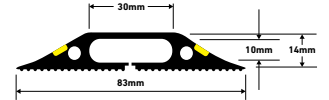
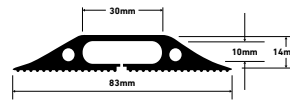
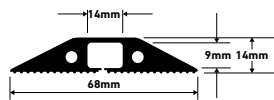

Medium Duty profiles uncoil to effectively lay flat across surfaces, while the tapered sloping sides are pedestrian-friendly.

The connector pins provide an effective friction-fit connection that can be pushed-in, then later pulled apart, in adjoining lengths – to cover whatever length of cable is required.

- Pre-split back retro-fits over cables
- 4mm x 9mm or 30mm x 10mm cavity options
- Ribbed non-slip base, pre-split rear for ease of use
- Flexible PVC - Neat tapered design, lengths uncoil to lay flat
- Fully safety tested and certified to BS EN 60670-1:2005

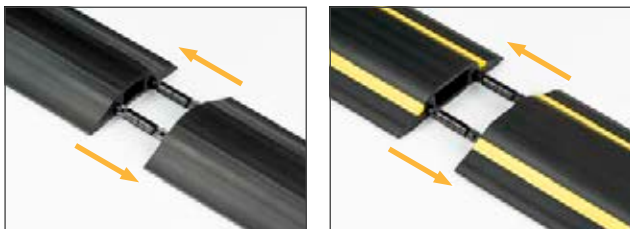
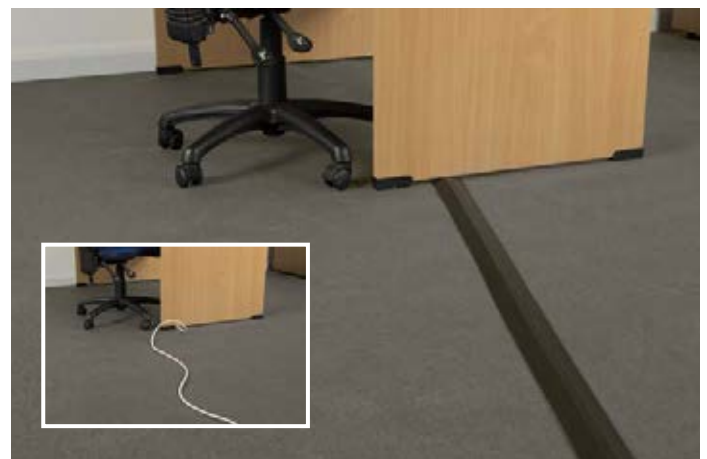

Linkable - Lengths supplied with 2 connector pins

Code	Description	Colour
FC68B	(L) 1.8m x (W) 68mm x (H) 14mm - Inner channel - (W) 14mm x (H) 9mm	Black
FC68B/9M	(L) 9.0m x (W) 68mm x (H) 14mm - Inner channel - (W) 14mm x (H) 9mm	Black
FC83B	(L) 1.8m x (W) 83mm x (H) 14mm - Inner channel - (W) 30mm x (H) 10mm	Black
FC83B/9M	(L) 9.0m x (W) 83mm x (H) 14mm - Inner channel - (W) 30mm x (H) 10mm	Black
FC83H	(L) 1.8m x (W) 83mm x (H) 14mm - Inner channel - (W) 30mm x (H) 10mm	Black/Yellow
FC83B/9M	(L) 9.0m x (W) 83mm x (H) 14mm - Inner channel - (W) 30mm x (H) 10mm	Black/Yellow

Rigid Single Channel Cable Protector

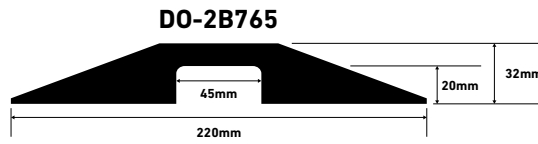
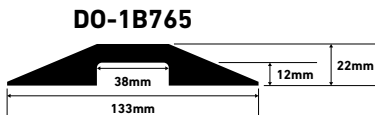

D-Line rigid Cable Protector lengths each have a simple and effective locking mechanism, so runs can be made in any length required.

Select 12mm or 20mm cavity height options according to cable diameters.

- Made from high-grade polyurethane, extremely robust
- Join by interlocking male:female connectors
- Tapered design & non-slip treads for pedestrian traffic
- Can accept up to 11.5t Axle Weight i.e. all vehicular traffic
- Durability gives exceptional value
- Fully safety tested and certified to BS7671:2008



Code	Description	Colour
DO-1B765	(L) 765mm x (W) 133mm x (H) 22mm Inner channel - (W) 38mm x (H) 12mm	Black
DO-2B765	(L) 765mm x (W) 220mm x (H) 32mm Inner channel - (W) 45 mm x (H) 20mm	Black

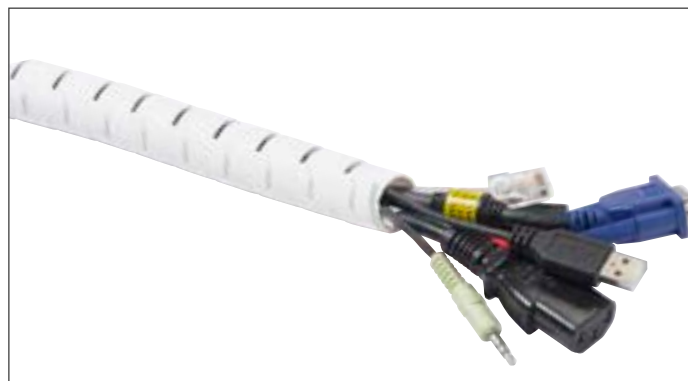
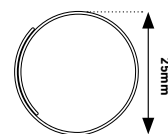

Simply place the cables in the zip tool, then pull the zip tool down along the length of the Zipper.

The cables then transfer from the tool into the length of Zipper, to provide an incredibly quick and easy way to neatly organise several cables.

The cut-outs along the length enable the Zipper to bend in tight radii.

- Ideal to conceal & protect longer runs of cables
- Quick and easy to use - scissor cut to length; insert cables in zip tool; put zip tool in to length; pull zip tool along length
- Flexible design and good resistance to oils/lubricants, acids & alkalis - suitable for use around plant and machinery too
- Zip tool included in pack
- Operating temperature -30°C to +85°C



Code	Description	Colour
CZ252.5W	(L) 2.5m - 25mm diameter	White
CZ252.5B	(L) 2.5m - 25mm diameter	Black

Socket Enclosures

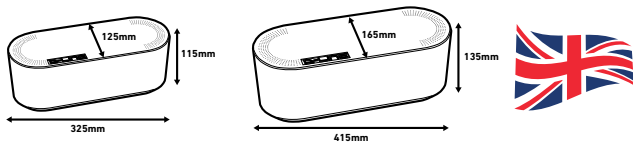

D-Line Socket Enclosures (aka Cable Tidy Units) provide the most popular solution to contain extension sockets and cable spaghetti. The smart tech design blends with modern surroundings. 3x rear cable entry/exit slots enable cables to be routed to left-side, right-side or vertical.

Fully safety tested, and produced from electrically-safe robust ABS material with an effective click-lock lid, these Socket Enclosures sort unsightly cables and contribute to a positive Health & Safety culture.

- Tidy, route & sort unsightly cable clutter
- Make surfaces easier to clean
- Make socket blocks less accessible
- Prevent feet snagging cables under desks - save entanglements and costly disconnections
- Produced using electrically-safe ABS material

Code	Description	Colour
EU/CTUSMLB/SW	(L) 325mm x (W) 125mm x (H) 115mm	Black
EU/CTUSMLW/SW	(L) 325mm x (W) 125mm x (H) 115mm	White
EU/CTULGEB/SW	(L) 415mm x (W) 165mm x (H) 135mm	Black
EU/CTULGEW/SW	(L) 415mm x (W) 165mm x (H) 135mm	White

Split Cable Tube

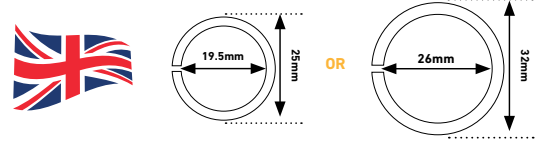

Cables can be manually inserted into Split Cable Tube to offer a neat way of organising a cluster of cables.

The 1.1m (3ft 7") length is ideal to sort cables dropping behind desks and TVs.

The LDPE material is very user-friendly to handle, and makes it easy to later add or remove cables.

- Tidy & protect several cables
- Ideal to contain cables dropping behind TVs and desks
- Pre-split - fits around existing cables
- Flexible & easiest to add or remove cables
- Fully safety tested and certified to EN 60695-2-11: 2014

Code	Description	Colour
CTT1.1/25B	(L) 1.1m - 25mm diameter	Black
CTT1.1/25W	(L) 1.1m - 25mm diameter	White
CTT1.1B	(L) 1.1m - 32mm diameter	Black
CTT1.1W	(L) 1.1m - 32mm diameter	White

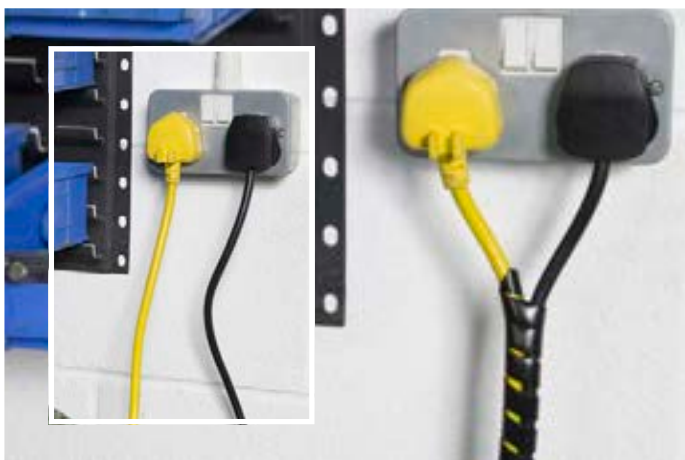
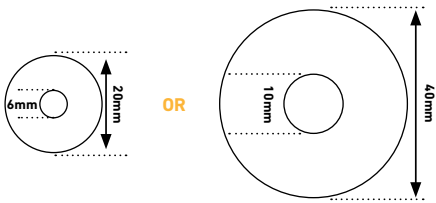

Cable Spiral Wrap is available in 2 sizes; the larger 10mm width version can expand to contain bundles of cables up to 40mm diameter; the smaller 6mm width version can expand to contain bundles of cables up to 20mm diameter.

Users simply wrap the Spiral around cables to give effective protection to cables.

This versatile solution allows cables to enter or exit along the length, so making a popular option for use in tight spaces.

- Versatile, easy to exit cables at any point along length
- Ideal for shorter runs of cable
- 1.5mm gauge LDPE material protects cable insulation

- Expands around bundles of cables up to 40mm diameter
- Good resistance to oils/lubricants, acids & alkalis
- Easy to cut to required length, then wrap by hand
- Fully safety tested and certified to EN 60695-2-11: 2014

Code	Description	Colour
CTW2.5B	(L) 2.5m - 10mm - 40mm diameter	Black
CTW2.5W	(L) 2.5m - 10mm - 40mm diameter	White
CTW3B	(L) 3m - 6mm - 20mm diameter	Black

Cable Band

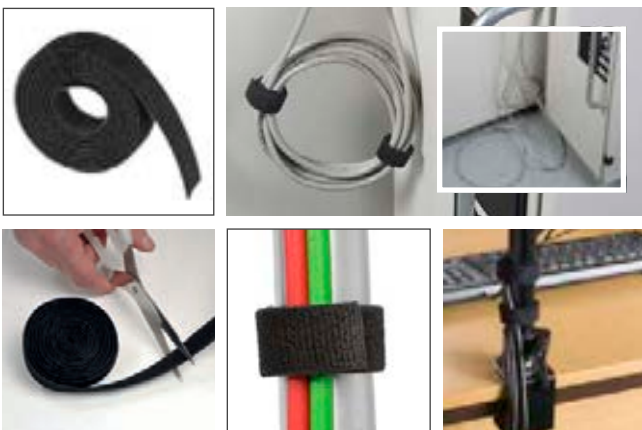

While commonly used as a reusable cable tie to secure cables to supports, this versatile hook & loop Band is ideal for multi-purpose applications.

Fully safety-tested, Cable Tidy Band can hold up to 10kg when fastened with 50mm overlap.

- Tested to hold up to 10kg with a 50mm overlap
- Hook & loop design
- Scissor cut as required; Re-usable
- Versatile 1.2m length



Code	Description	Colour
HLBAND1.2B	(L)1.2m x (W) 20mm	Black

Other guides by D-Line...

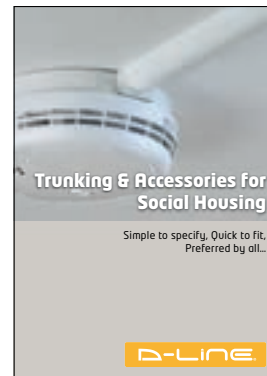
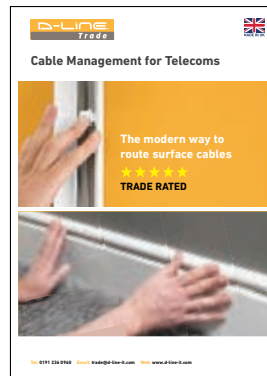
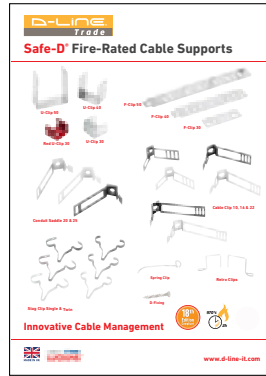
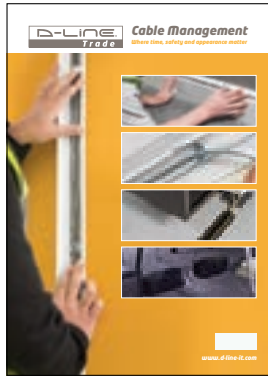

D-Line Trade



dlinetrade



D-Line (Trade)



D-Line (Europe) Limited

Alder Road, North Shields, NE29 8SD UK

Tel: +44 (0)191 236 0960 Email: trade@d-line-it.com Web: www.d-line.com